



A Corporate Presentation 2011

What is Precise Engineering

- Precise is a specialist in scaled-down modeling solutions (*micro-modeling*)
- Provides unique solutions to improve efficiency of exhibition/ presentation of *large and complex engineering products and systems*

Portfolio-1: Micro Product Models



Cross Section Of Boiler

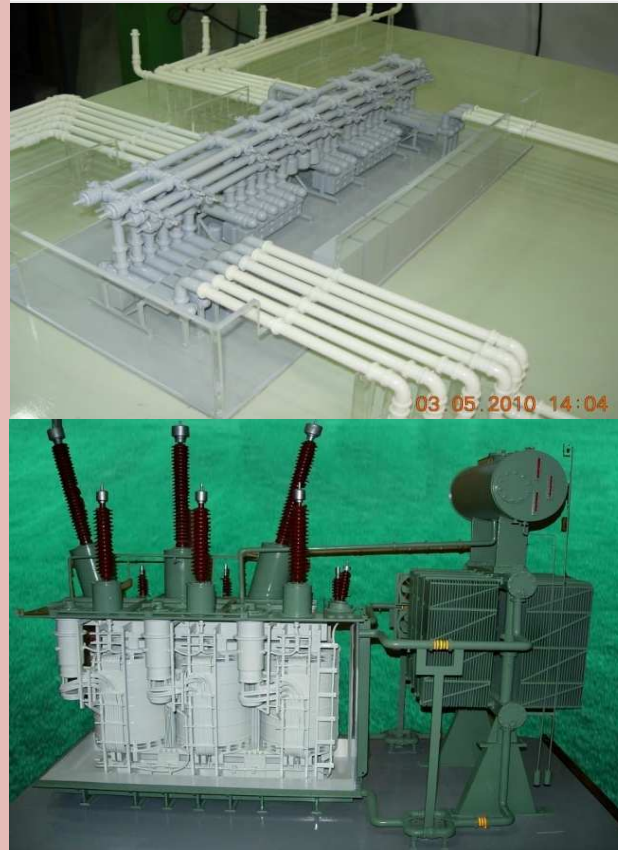

Applications

- Demonstration center
- Customer education
- Training

Portfolio -2: Full Blown Micro-Model

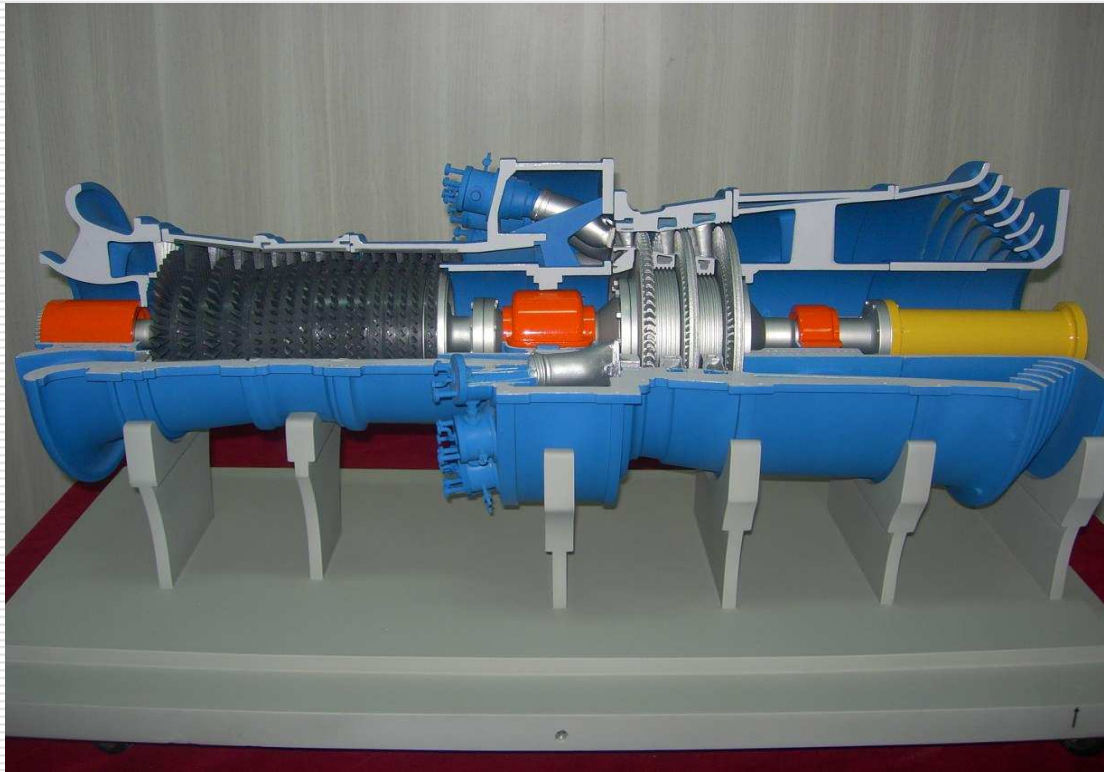

Applications

- Technical training
- Design Review
- Exhibition
- Showcasing

Cut sectional, 16 component Micro model of Gas Turbine

Portfolio -3: Assembly/disassembly



Applications

- Technical training
- Design Review
- Exhibition
- Showcasing

Portfolio 4 Piping model



Piping Model

Applications

Showcasing

Piping review

Customer demonstration

Portfolio-5: Plant Model



Applications

- Exhibition
- Demonstration center
- Customer education

Coal Gasification Plant Model

Portfolio-6: Power Plant



Working model of Thermal Power Plant

Applications

- Guided tour
- Exhibition
- Showcasing
- Museum

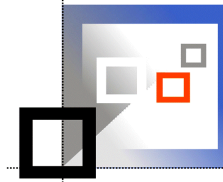

Portfolio-7: Equipment Assembly

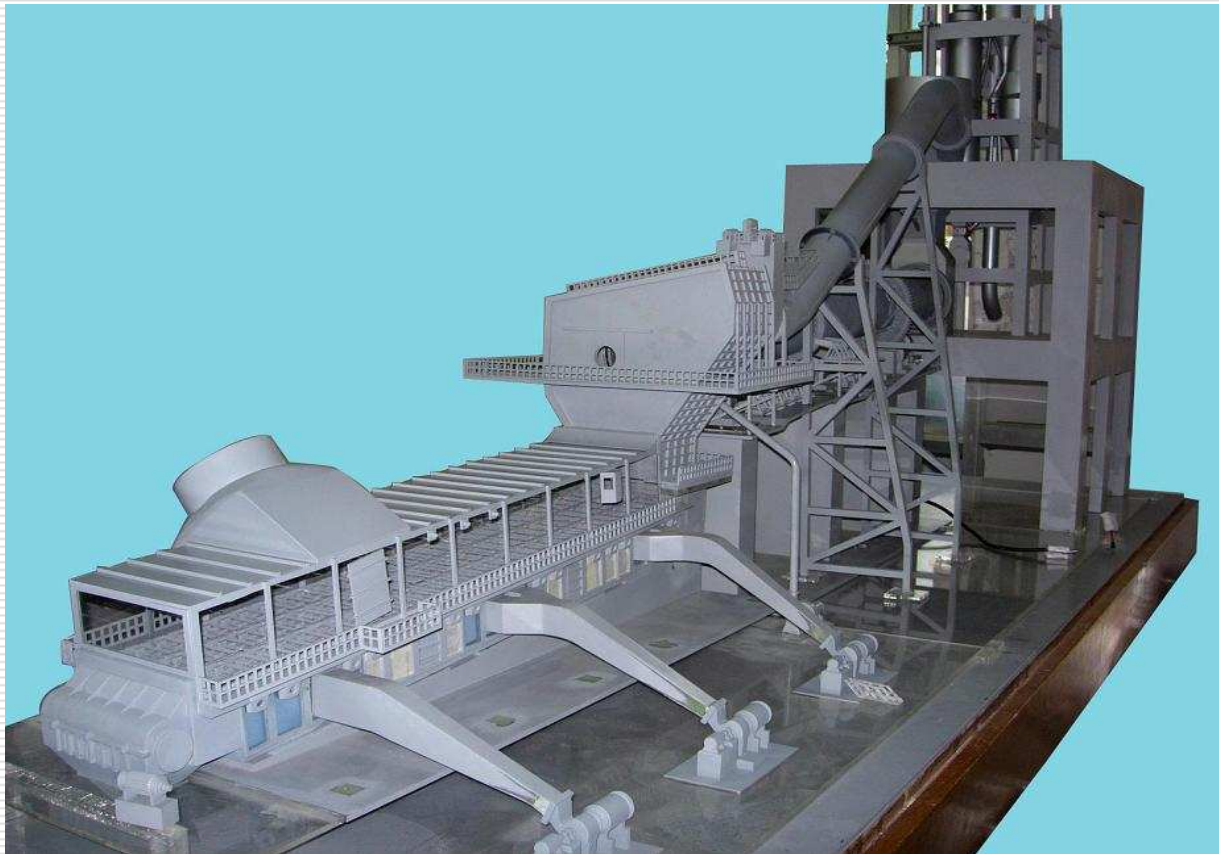

Applications

- Guided tour
- Exhibition
- Showcasing
- Technical Training

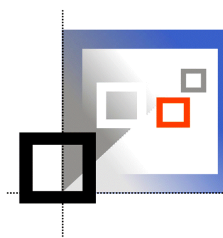

Portfolio-8: Power Transmission & Distribution



Applications

- Guided tour
- Exhibition
- Showcasing
- Museum

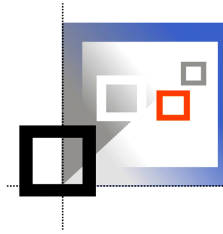

Portfolio-9: Steam Turbine Assembly

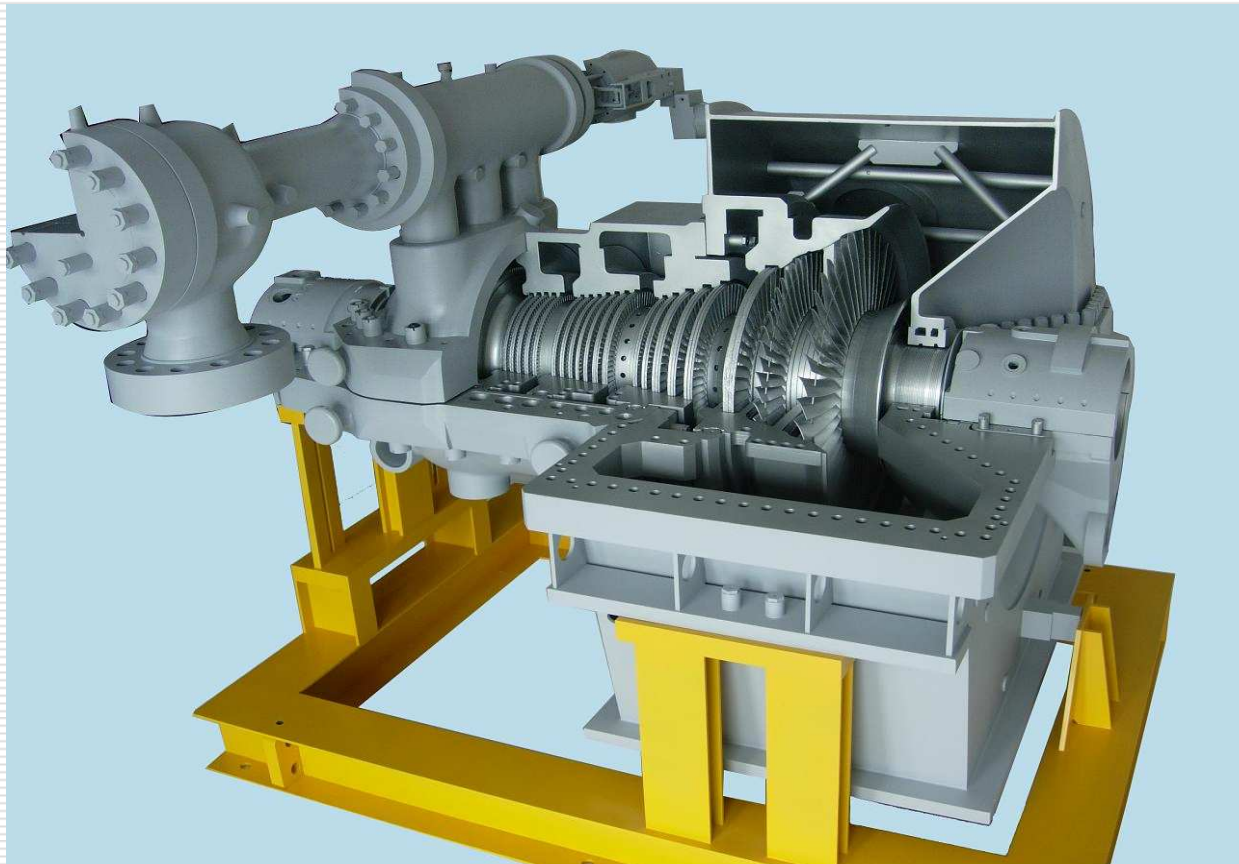

Applications

- Exhibition
- Showcasing
- Training

Application of micro-Models

- ❑ Showcasing: in exhibition, customer presentation, board room and corporate office
- ❑ Walk-thru exercises and Workflow simulations
- ❑ Instructions & Training program
- ❑ Demonstration
- ❑ Gift & memento

Benefits of using micro-Models

- ❑ Saves money in product presentation
- ❑ Saves time in product promotion, by simplifying logistics in exhibiting large products
- ❑ Offers Better visualization of complexities and special features
- ❑ Offers touch and feel effect of product
- ❑ Provides opportunity to showcase system integration

Representative Customers

- Over 75 strong customer base in 9 years
 - Power Products : ABB, GE, BHEL, KODAK, Schnieder
 - Cement: Aditya Birla, Promac, FLSmidth, J&K
 - Power Infrastructure: Alstom(Areva),ABB,S IEMENS, JSPL, Powergrid, NHDC, Easun, JSW, Tecnimont,JSW KSK Energy
 - R&D : DRDO, BEL, Indian Space Research
 - Software/ eLearning: SIFY, EDC, Philips
 - Architectural: TESCO, TVS, ING-Vysya



Customer Locations

- USA
- Sweden
- South Africa
- Germany
- Qatar
- New Caledonia
- India

Easy to carry models

Why Precise

- Precision
 - Engineering solutions
- End to end expertise
 - Definition to installation
- Best business terms
 - Flexible execution and delivery
- Cost effectiveness
 - Efficient processes
- Hype Free Interactions
 - Transparent interactions

The Team

- Senior Management



Dr. Shridhar Lolla,
Chief Architect



Nityananda P Mahale, Manager-
Engineering



C. Srinivas, Manager-
Operations

- + 15 skilled resources
- + specialist partners

Customer's Role: key success factor

- Provide intent of model
- Engineering Drawings
- Description
- Photographs
- Access to actual product/ project/ site
- Interface to Domain experts

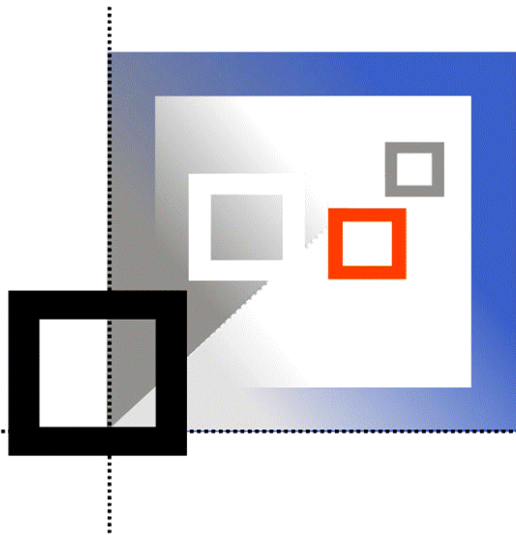

PRECISE ENGINEERING

Miniaturization Experts

<http://www.enggmodels.com>

E-mail: nitya@enggmodels.com